

**EN**

**OPERATING MANUAL**  
FAN HEATER



EN This product is only suitable for well insulated spaces or occasional use.

**Table of contents**

Notes regarding the operating manual..... 2

Safety ..... 2

Information about the device..... 5

Transport and storage..... 5

Assembly and start-up..... 5

Operation ..... 6

Errors and faults..... 8

Maintenance ..... 9

Technical annex..... 9

Disposal ..... 11

**Notes regarding the operating manual**

**Symbols**

 **Warning of electrical voltage**  
This symbol indicates dangers to the life and health of persons due to electrical voltage.

 **Warning of hot surface**  
This symbol indicates dangers to the life and health of persons due to hot surface.

 **Warning**  
This signal word indicates a hazard with an average risk level which, if not avoided, can result in serious injury or death.

 **Caution**  
This signal word indicates a hazard with a low risk level which, if not avoided, can result in minor or moderate injury.

**Note**  
This signal word indicates important information (e.g. material damage), but does not indicate hazards.

 **Info**  
Information marked with this symbol helps you to carry out your tasks quickly and safely.

 **Follow the manual**  
Information marked with this symbol indicates that the operating manual must be observed.

You can download the current version of the operating manual and the EU declaration of conformity via the following link:

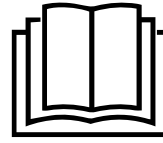

TFH 2000 E



<https://hub.trotec.com/?id=43425>

**Safety**

**Read this manual carefully before starting or using the device. Always store the manual in the immediate vicinity of the device or its site of use.**

 **Warning**  
**Read all safety warnings and all instructions.**  
Failure to follow the warnings and instructions may result in electric shock, fire and/or serious injury.  
**Save all warnings and instructions for future reference.**  
This appliance can be used by children aged from 8 years and above and persons with reduced physical, sensory or mental capabilities or lack of experience and knowledge if they have been given supervision or instruction concerning use of the appliance in a safe way and understand the hazards involved.  
Children shall not play with the appliance. Cleaning and user maintenance shall not be made by children without supervision.

 **Warning**  
Children of less than 3 years should be kept away from the device unless continuously supervised.  
Children aged from 3 years and less than 8 years shall only switch on/off the appliance provided that it has been placed or installed in its intended normal operating position and they have been given supervision or instruction concerning use of the appliance in a safe way and understand the hazards involved.  
Children aged from 3 years and less than 8 years shall not plug in, regulate and clean the appliance or perform user maintenance.



### Warning

Do not use the device in small rooms if persons are present who cannot leave the room independently and who are not under constant supervision.

- Do not use the device in potentially explosive rooms or areas and do not install it there.
- Do not use the device in aggressive atmosphere.
- Only put up the device in an upright, stable position on firm ground.
- Let the device dry out after a wet clean. Do not operate it when wet.
- Do not use the device with wet or damp hands.
- Do not expose the device to directly squirting water.
- Never insert any objects or limbs into the device.
- Do not cover the device during operation.
- Do not remove any safety signs, stickers or labels from the device. Keep all safety signs, stickers and labels in legible condition.
- Do not sit on the device.
- This device is not a toy. Keep away from children and animals. Do not leave the device unattended during operation.
- Check accessories and connection parts for possible damage prior to every use of the device. Do not use any defective devices or device parts.
- Ensure that all electric cables outside of the device are protected from damage (e.g. caused by animals). Never use the device if electric cables or the power connection are damaged!
- The mains connection must correspond to the specifications in the Technical annex.
- Insert the mains plug into a properly fused mains socket.
- Observe the device's power input, cable length and intended use when selecting extensions to the power cable. Completely unroll extension cables. Avoid electrical overload.
- Before carrying out maintenance, care or repair work on the device, remove the mains plug from the mains socket. Hold onto the mains plug while doing so.
- Switch the device off and disconnect the power cable from the mains socket when the device is not in use.
- Do not under any circumstances use the device if you detect damages on the mains plug or power cable. If the power cable is damaged, it must be replaced by the manufacturer, its service agent or similarly qualified persons in order to avoid a hazard. Defective power cables pose a serious health risk!

- When positioning the device, observe the minimum distances from walls and other objects as well as the storage and operating conditions specified in the Technical annex.
- Keep a safety distance of at least 1 m between the air inlet and the air outlet of the device and all combustible materials such as textiles, curtains, beds and sofas.
- Make sure that the air inlet and outlet are not obstructed.
- Make sure that the suction side is kept free of dirt and loose objects.
- Do not place the device on combustible ground.
- Only use original spare parts, for otherwise safe and functional operation cannot be ensured.
- Allow the device to cool down before transport and/or maintenance work.
- The device must not be positioned directly beneath a wall socket.
- Do not use the device if it has been dropped or if it shows visible signs of damage.

### Intended use

The device is only suitable for well insulated spaces or occasional use.

The fan heater serves the purpose of heating and ventilating closed rooms. The device was designed for private usage and is not suited for commercial use. The device is particularly well suited for additional heating. The device is only intended for floor installation.

### Foreseeable misuse

- Do not place the device on wet or flooded ground.
- Do not place any objects, e.g. clothing, on the device.
- Do not use this device in the vicinity of fuel, solvents, varnishes or other easily inflammable vapours or in rooms where these substances are stored.
- Do not use the device out of doors.
- Do not use the device in wet rooms (e.g. bathrooms or laundry rooms).
- Never immerse the device in water.
- Do not use the device for heating vehicles.
- Never heat rooms with a cubature of less than 4 m<sup>3</sup>. Risk of overheating!
- Any use other than the intended use is regarded as a reasonably foreseeable misuse.
- Do not make any unauthorised modifications, alterations or structural changes to the device.

**Personnel qualifications**

People who use this device must:

- be aware of the dangers that occur when working with electric devices in damp areas.
- have read and understood the operating manual, especially the Safety chapter.

Maintenance tasks which require the housing to be opened must only be carried out by specialist electrical companies or by Trotec.

**Symbols on the device**

Symbols	Meaning
	This symbol located on the device indicates that it is prohibited to place objects (such as towels, clothes etc.) above or directly in front of the device. In order to avoid overheating and fire hazards, the heater must not be covered.

**Residual risks**



**Warning of electrical voltage**

Work on the electrical components must only be carried out by an authorised specialist company!



**Warning of electrical voltage**

Before any work on the device, remove the mains plug from the mains socket!  
Do not touch the mains plug with wet or damp hands.  
Hold onto the mains plug while pulling the power cable out of the mains socket.



**Warning of electrical voltage**

Risk of electric shock!  
The device must not come into contact with water, otherwise there is a risk of an electric shock!  
Do not use this heating device in wet rooms!



**Warning of hot surface**

Parts of this appliance can become very hot and cause burns. Particular attention is to be paid when there are children or vulnerable persons present!



**Warning**

Improper handling entails a risk of burning and electric shock.  
Only use the device as intended!



**Warning**

Dangers can occur at the device when it is used by untrained people in an unprofessional or improper way!  
Observe the personnel qualifications!



**Warning**

The device is not a toy and does not belong in the hands of children.



**Warning**

Risk of suffocation!  
Do not leave the packaging lying around. Children may use it as a dangerous toy.



**Warning**

Improper installation entails a risk of fire.  
Do not place the device on combustible ground.  
Do not place the device on high-pile carpets.



**Warning**

In order to avoid overheating and fire hazards, the device must not be covered!

**Behaviour in the event of an emergency**

1. Switch the device off.
2. In an emergency, disconnect the device from the mains feed-in: Hold onto the mains plug while pulling the power cable out of the mains socket.
3. Do not reconnect a defective device to the mains.

**Overheating protection**

The device is provided with a safety thermostat which is activated by overheating of the device (when exceeding the operating temperature).

Once the safety thermostat has switched itself on, the heating will be turned off. The fan keeps running.

When the device has cooled down sufficiently, the heating will be switched back on.

Investigate the cause of overheating.

If the safety thermostat does not switch in the event of overheating, the overheating protection will be tripped. In that case the device switches off completely. If so, please contact the customer service to have the overheating protection replaced.

**Tilt protection**

The device comes equipped with a tilt protection. The tilt protection is a safety device intended to minimize the risk of fire in case the device is tipped over inadvertently. The device will be switched off when knocked over (or if its upright position is changed in any other manner).

The tilt protection is tripped when the device is inclined by a few degrees out of its vertical position. An acoustic signal is emitted and the LEDs (6), (7) and (8) start flashing. The heating is switched off, the fan keeps running for approx. 15 seconds until it is switched off as well.

Once the device is placed back in vertical position and on solid ground, it switches back on and can again be used as usual.

## Information about the device

### Device description

The electric heater TFH 2000 E serves to generate and distribute warm air, e.g. in interior spaces.

The device generates heat by means of a heating element. The air surrounding the heating element is heated. The heated air is blown into the room by a fan.

The device is equipped with an integrated thermostat and so generates a constant flow of warm air. In addition, you can set a desired target temperature (18 °C to 30 °C) at the device.

The device is further equipped with an overheating protection and an integrated tilt protection.

Fan operation without heating function is also possible.

### Device depiction

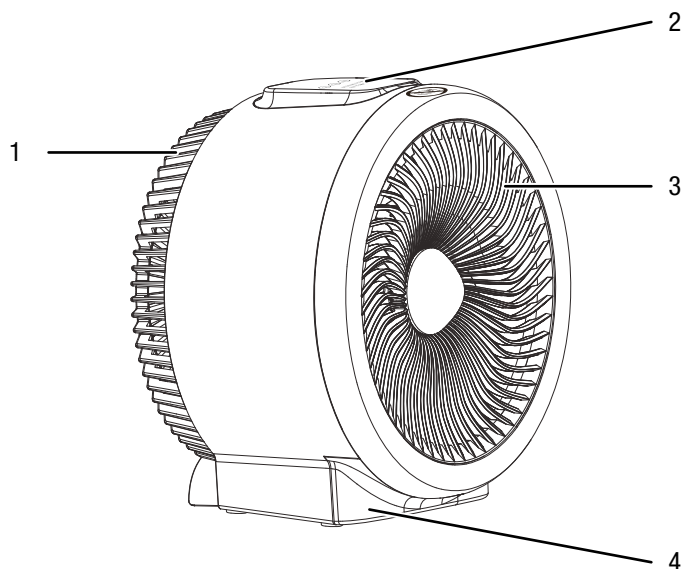

No.	Designation
1	Air inlet with transport handle
2	Control panel
3	Air outlet
4	Foot

## Transport and storage

### Note

If you store or transport the device improperly, the device may be damaged.

Note the information regarding transport and storage of the device.

### Transport

To make the device easier to transport, it is fitted with a carry handle.

**Before** transporting the device, observe the following:

- Switch the device off.
- Hold onto the mains plug while pulling the power cable out of the mains socket.
- Do not use the power cable to drag the device.
- Allow the device to cool down sufficiently.

### Storage

**Before** storing the device, proceed as follows:

- Hold onto the mains plug while pulling the power cable out of the mains socket.
- Allow the device to cool down sufficiently.

When the device is not being used, observe the following storage conditions:

- Store the device in a dry location and protected from frost and heat.
- Store the device in an upright position where it is protected from dust and direct sunlight.
- If required, use a cover to protect the device from invasive dust.
- Place no further devices or objects on top of the device to prevent it from being damaged.

## Assembly and start-up

### Scope of delivery

- 1 x Fan heater
- 1 x Manual

### Unpacking the device

1. Open the cardboard box and take the device out.
2. Completely remove the packaging.
3. Fully unwind the power cable. Make sure that the power cable is not damaged and that you do not damage it during unwinding.

**Start-up**



**Info**

Odours might arise upon initial start-up or after a longer period of non-use.

When positioning the device, observe the minimum distance from walls or other objects as described in the chapter Technical annex.

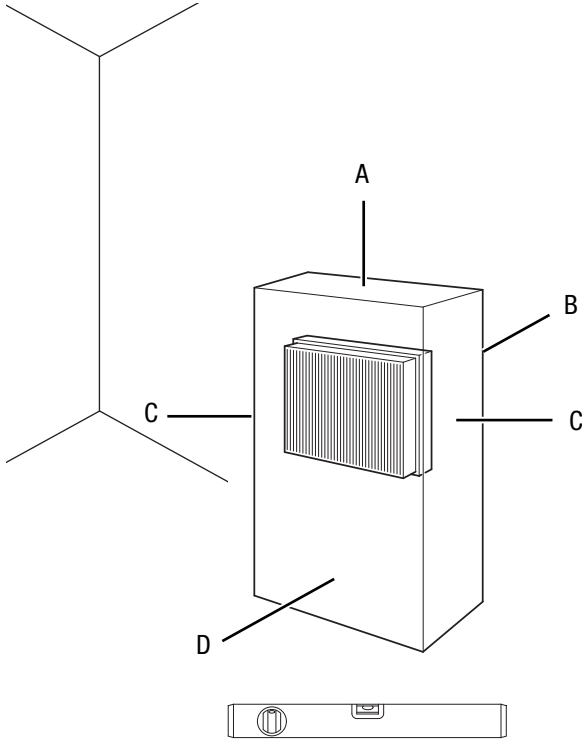

- Before restarting the device, check the condition of the power cable. If there are doubts as to the sound condition, contact the customer service.
- Position the device on even, stable and heat-insensitive ground in a way to prevent it from tipping over.
- Do not create tripping hazards when laying the power cable or other electric cables, especially when positioning the device in the middle of the room. Use cable bridges.
- Make sure that extension cables are completely unrolled.
- Make sure that no curtains or other objects interfere with the air flow.
- Do not position the device directly below a wall socket.
- Put up the device in a way that no person, animal or plant is positioned in its direct flow path upon switch-on.
- Make sure that the device cannot come into contact with moisture or water.

**Connecting the power cable**

- Insert the mains plug into a properly fused mains socket.
- Make sure that the power cable is guided along the back of the device. Never guide the power cable along the front of the device!

**Operation**

- Avoid open doors and windows.

**Control panel**

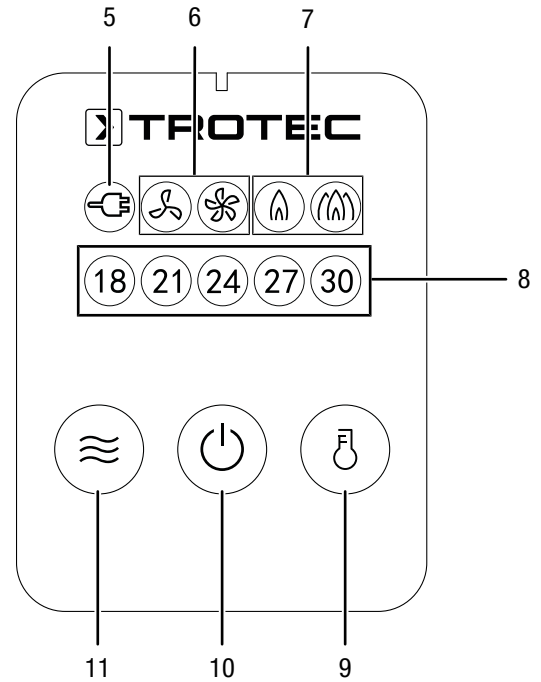

No.	Designation	Meaning
5	Mains plug LED	Illuminated when the mains plug is inserted.
6	Fan stage LEDs	Stage 1 = low fan speed Stage 2 = high fan speed
7	Heating level LEDs	Level 1: 1200 W Level 2: 2000 W
8	Temperature LEDs	Indicate the preselected target temperature.
9	Temperature button	For setting the desired target temperature
10	Power button	For switching the device on and off
11	Mode button	For switching between the operating modes



**Info**

An acoustic signal is emitted each time a setting is activated.



## Switching the device on

Once you have completely installed the device as described in the Start-up chapter, you can switch it on.



### Info

The device will not be switched on until the room temperature falls below the temperature set at the room thermostat.

## Setting the operating mode

The device has the following operating modes:

- Heating function
- Fan function

## Setting the heating level



### Info

Choose the smaller power stage e.g. for a smaller room. Should it turn out to be insufficient, switch to the higher level.

1. Press the Power button (10).
  - ⇒ The device starts in the operating mode and with the temperature previously selected.
2. Press the *Mode* button (11) until the LED for the desired heating level (7) is illuminated.
  - ⇒ heating level 1: 1200 W
  - ⇒ heating level 2: 2000 W

## Setting the target temperature

1. Repeatedly press the *Temperature* button (9) until the LED for the desired target temperature (8) is illuminated.
  - ⇒ The device now automatically maintains the desired temperature level.
  - ⇒ In this operating mode you cannot adjust the fan speed.

The room thermostat controls the room temperature automatically:

- When the set value is exceeded, the heating switches off. The fan keeps running for approx. 15 seconds and then switches off as well.
- The LED for the preselected temperature (8) flashes.
- When falling below the set value, both the heating and the ventilation will automatically be switched back on.



### Info

The desired room temperature should be higher than the current room temperature.

## Cold air operation

If you want to use the device as fan, press the *Mode* button (11) until the LED for the desired fan stage (6) is illuminated.

The target temperature cannot be adjusted in this operating mode.

## Fan rundown operation

In order to discharge the trapped heat from the fan heater, the device will run in fan rundown operation after standby mode has been activated. Once the rundown period has been completed, the fan switches off automatically.

## Shutdown



### Warning of electrical voltage

Do not touch the mains plug with wet or damp hands.

- Switch the device to standby mode by pressing the Power button (10).
- The fan keeps running for approx. 15 seconds and then switches off automatically.
- Wait until the fan has completed the rundown operation.
- Hold onto the mains plug while pulling the power cable out of the mains socket.
- Allow the device to cool down completely.
- Clean the device according to the Maintenance chapter.
- Store the device according to the Transport and storage chapter.

## Errors and faults



### Warning of electrical voltage

**Tasks which require the device to be opened must only be carried out by authorised specialist companies or by Trotec.**

The device has been checked for proper functioning several times during production. If malfunctions occur nonetheless, check the device according to the following list.

#### The device does not start:

- Check the power connection.
- Check the power cable and mains plug for damage. If you notice damages, do not try to take the device back into operation.  
If the supply cord is damaged, it must be replaced by the manufacturer, its service agent or similarly qualified persons in order to avoid a hazard.
- Check the on-site fusing.
- Check the room temperature. The room thermostat may have switched off, because the desired room temperature has been reached.
- The motor might be defective. Have a defective motor replaced by a specialist electrical company.
- Check whether the device is standing upright and on level ground. The tilt protection may have been tripped owing to the fact that the device was knocked over. Always put up the device in an upright position on a suitable, sufficiently dimensioned surface.
- The room thermostat might be defective. Have a defective room thermostat replaced by a specialist electrical company.
- The overheating protection may have been tripped. Have a specialist electrical company or Trotec check the electrics and replace the overheating protection.
- Wait for 10 minutes before restarting the device. If the device is not starting, have the electrics checked by a specialist company or by Trotec.

#### The device is switched on, the fan is operating, the heating is not:

- Check whether a heating level is selected.
- Check the room temperature. The room thermostat may have switched off, because the desired room temperature has been reached.
- Check whether the overheating protection has tripped (see chapter Safety).
- The heating resistor might have blown. Have a defective heating resistor replaced by a specialist electrical company.

- The room thermostat might be defective. Have a defective room thermostat replaced by a specialist electrical company.

#### The fan is not running:

- Check whether the device is switched on.
- Check the power connection.
- Check the power cable and mains plug for damages.
- Check whether the fan stage has been selected.
- Check whether the room thermostat is switched on. Set a temperature that is higher than the current room temperature.
- The fan motor might be defective. Have a defective fan motor replaced by a specialist electrical company.

#### The air current is reduced:

- Check the air inlet and outlet. Make sure that air inlet and outlet are not obstructed. Remove any dirt. Observe the minimum distance from walls or other objects according to the technical data.

#### The device is loud or vibrates:

- Check whether the device is set up in a stable and upright position.

#### Note

Wait for at least 3 minutes after maintenance and repair work. Only then switch the device back on.

#### The device still does not operate correctly after these checks:

Please contact the customer service. If necessary, bring the device to an authorised specialist electrical company or to Trotec for repair.



## Maintenance

### Activities required before starting maintenance



#### Warning of electrical voltage

Do not touch the mains plug with wet or damp hands.

- Switch the device off.
- Hold onto the mains plug while pulling the power cable out of the mains socket.
- Allow the device to cool down completely.



#### Warning of electrical voltage

**Tasks which require the device to be opened must only be carried out by authorised specialist companies or by Trotec.**

### Cleaning the housing



#### Warning of electrical voltage

Never immerse the device in water!

Clean the housing with a soft, damp and lint-free cloth. Make sure that no moisture enters the housing. Protect electrical components from moisture. Do not use any aggressive cleaning agents such as cleaning sprays, solvents, alcohol-based or abrasive cleaners to dampen the cloth.

Wipe the housing dry after cleaning.

## Technical annex

### Technical data

Parameter	Value
Model	TFH 2000 E
Heating capacity	level 1: 1200 W level 2: 2000 W
Amount of air	level 1: 204.51 m <sup>3</sup> /h level 2: 277.28 m <sup>3</sup> /h
Operating range	0 °C to 35 °C
Mains connection	220–240 V, 50 Hz
Max. power input	2000 W
Nominal current consumption	8.7 A
Plug type	CEE 7/17
Cable length	1.65 m
Protection class	II / 
Type of protection	IPX0
Overheating protection	65 °C
Weight	2 kg
Dimensions (length x width x height)	185 x 255 x 250 (mm)
Minimum distance to walls or other objects	A: top: 50 cm B: rear: 50 cm C: side: 50 cm D: front: 120 cm

Information requirements for electrical local space heaters

Parameter	Value / item
Model	TFH 2000 E
<b>Heat output</b>	
Nominal heat output $P_{nom}$	2 kW
Minimum heat output (indicative) $P_{min}$	1.2 kW
Maximum continuous heat output $P_{max,c}$	2 kW
<b>Auxiliary electricity consumption</b>	
At nominal heat output $el_{max}$	1.919
At minimum heat output $el_{min}$	1.156
In standby mode $el_{sb}$	0.298
<b>Type of heat input</b>	
Manual heat charge control, with integrated thermostat	NO
Manual heat charge control with room and/or outdoor temperature feedback	NO
Electronic heat charge control with room and/or outdoor temperature feedback	NO
Fan assisted heat output	NO
<b>Type of heat output/room temperature control</b>	
Single-stage heat output, no room temperature control	NO
Two or more manual stages, no room temperature control	YES
With mechanic thermostat room temperature control	NO
With electronic room temperature control	YES
With electronic room temperature control plus day timer	NO
With electronic room temperature control plus week timer	NO
<b>Other control options</b>	
Room temperature control, with presence detection	NO
Room temperature control, with open window detection	NO
With distance control option	NO
With adaptive start control	NO
With working time limitation	NO
With black bulb sensor	NO
Contact details	Trotec GmbH Grebbeener Straße 7 D-52525 Heinsberg

NA = not applicable

## Disposal

Always dispose of packing materials in an environmentally friendly manner and in accordance with the applicable local disposal regulations.



The icon with the crossed-out waste bin on waste electrical or electronic equipment stipulates that this equipment must not be disposed of with the household waste at the end of its life. You will find collection points for free return of waste electrical and electronic equipment in your vicinity. The addresses can be obtained from your municipality or local administration. You can also find out about other return options that apply for many EU countries on the website <https://hub.trotec.com/?id=45090>. Otherwise, please contact an official recycling centre for electronic and electrical equipment authorised for your country.

The separate collection of waste electrical and electronic equipment aims to enable the re-use, recycling and other forms of recovery of waste equipment as well as to prevent negative effects for the environment and human health caused by the disposal of hazardous substances potentially contained in the equipment.

### Only for United Kingdom

According to Waste Electrical and Electronic Equipment Regulations 2013 (SI 2013/3113) (as amended) devices that are no longer usable must be collected separately and disposed of in an environmentally friendly manner.

Trotec GmbH

Grebener Str. 7  
D-52525 Heinsberg

☎ +49 2452 962-400

☎ +49 2452 962-200

✉ [info@trotec.com](mailto:info@trotec.com)

[www.trotec.com](http://www.trotec.com)